

## Orbital Research's Universal Mux Tee

The Orbital MT25/40 Mux Tee may not dice or slice, and it may not have a pair of scissors and a screwdriver built in, but there is a lot of universality and flexibility designed into its concept - it can insert or extract the 10 MHz reference signal, it can be used to insert or extract DC. It can be used as a Bias Tee, as a Mux Tee, or as a Diplexer. You can have a choice of connectors and it can perform L band impedance transforms.

It comes in standard (2.5 amp), and high power (4.0 amp) versions.

It can be combined with one of our built-for-satellite oscillators. A pair of them are often used with an oscillator for use with combined horizontal and vertical polarity systems.

It is properly weather sealed and usable indoors or out. Unused ports do not have to be terminated.

It is perfect for use in a test kit to provide an access point for monitoring a system or for performing diagnostics.

Best of all, we keep common impedance configurations in stock, and they can arrive at your location with your choice of connectors in good time for your project.

And there are so many ways to use our MT25/40s...

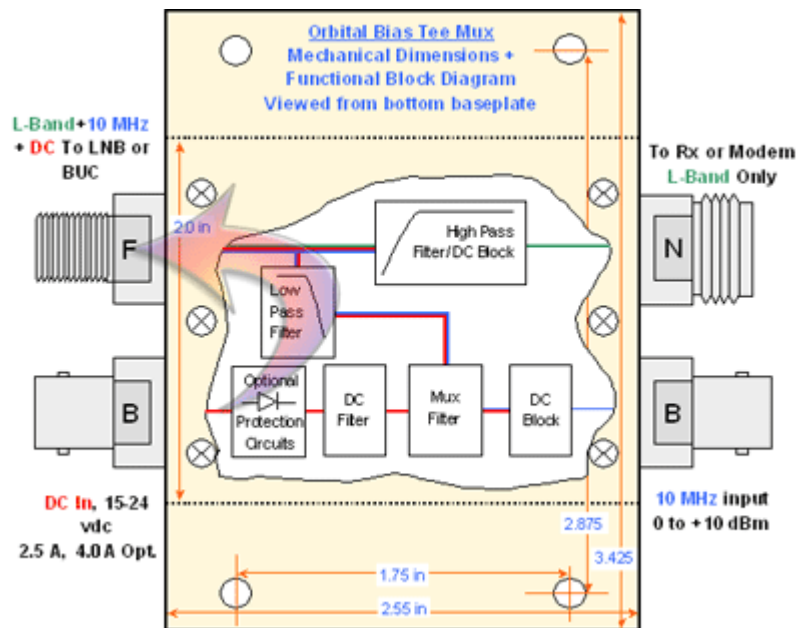

**As a Bias Tee, the MT25/40** injects and filters external DC to the LNB while providing exceptionally low thru loss and high-pass filtering of the L-band signal. What previously took a mixed bag of separate components is now available in an integrated bandpass-filtered and power-conditioned one-box solution ready for 'Back O Rack' mounting.

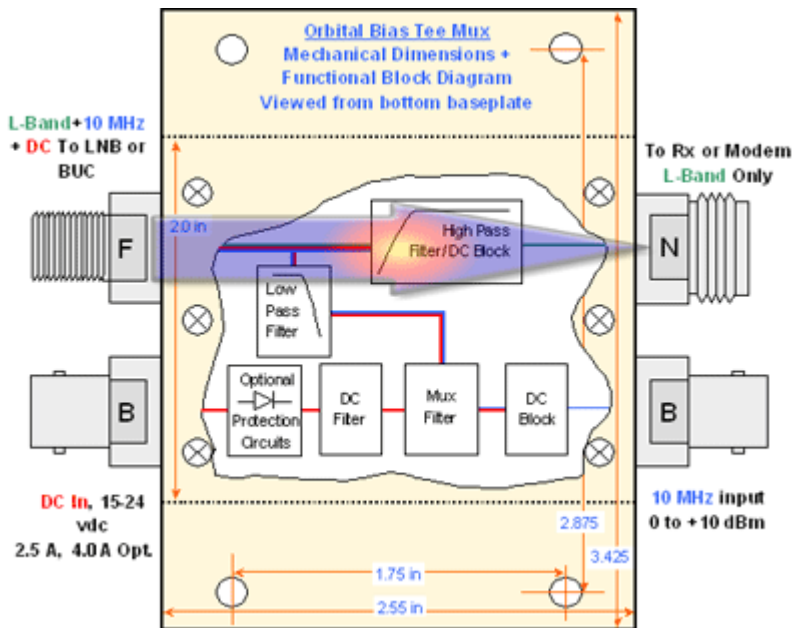

As a high pass filter and DC block for a receiver or modem.

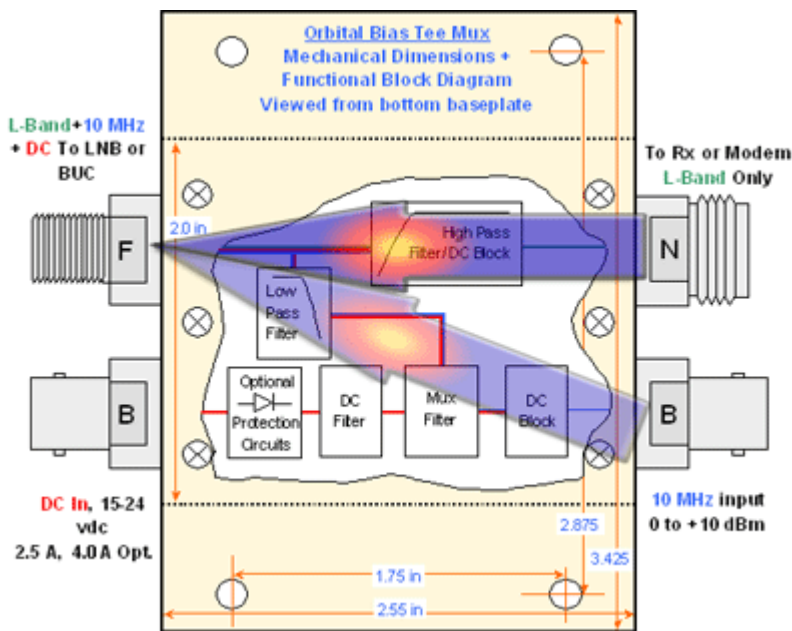

As a Diplexer to support a BUC, it becomes a System Interface Product (SIP), that combines a 10 MHz reference signal and L-Band output into one feed to a BUC. The **MT25/40 (as a Diplexer)** ensures low insertion loss, but high port-to-port isolation. Lock your BUC with the filtered diplexer. Puts the 10 MHz reference signal out to the BUC to lock it, and passes and filters the L-Band signal on the same line from the BUC.

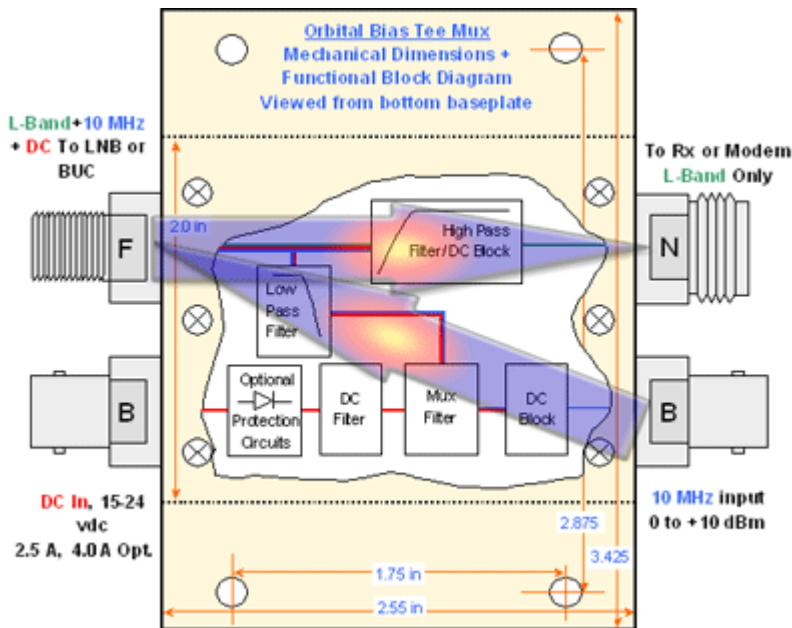

**As a Diplexer to support a LNB**, it becomes a System Interface Product (SIP), that combines a 10 MHz reference signal to an LNB, and L-Band output into one feed to a receiver. The **MT25/40 (as a Diplexer)**, ensures low insertion loss, but high port-to-port isolation. Lock your LNB with the filtered diplexer. Puts the 10 MHz reference signal out to the LNB to lock it, and passes and filters the L-Band signal on the same line from the LNB or to the receiver.

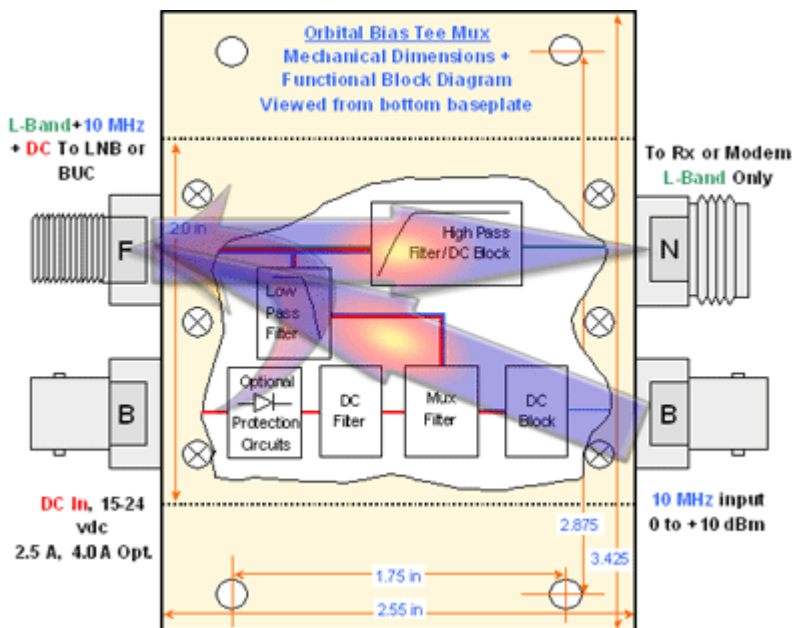

**As a MuxTee the MT25/40 Mux/Tee** integrates the L-band and DC filters of a **Bias Tee** with a 10 MHz Lowpass filter and an optional 20 MHz notch filter of a **Diplexer** to multiplex a 10 MHz external reference oscillator signal to your LNB or transmitter. What previously took a mixed bag of separate components is now available in an integrated bandpass-filtered and power-conditioned one-box solution ready for 'Back O Rack' mounting.

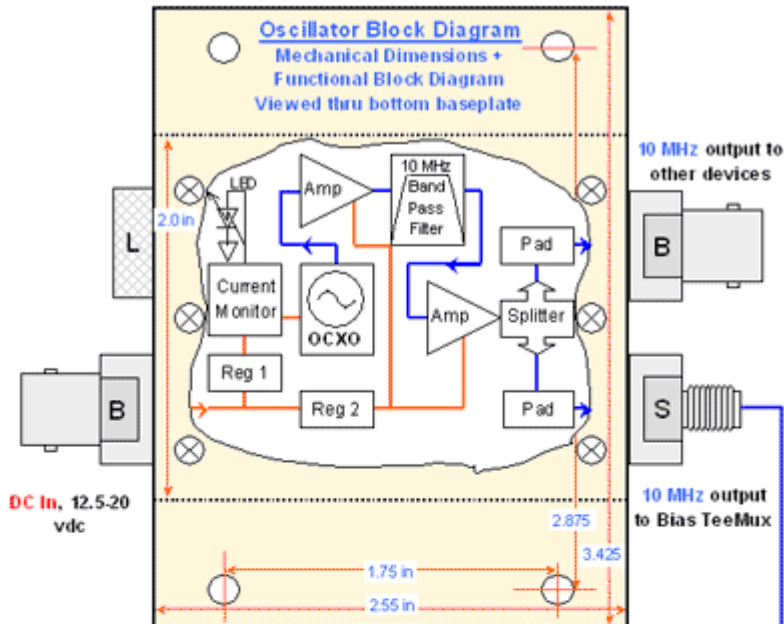

The **MT25/40** can be combined with one of our standard TCXO or precision OCXO oscillators, to provide a high quality 10 MHz source for your system.

It can even be combined with a **Master Oscillator (or Precision Oscillator)**, and a **10 MHz Splitter** in one package to supply 10 MHz to up to four devices.

A pair of **MT25/40**'s can be attached to an oscillator module to bring both horizontal and vertical feeds under the discipline of a single 10 MHz reference oscillator.

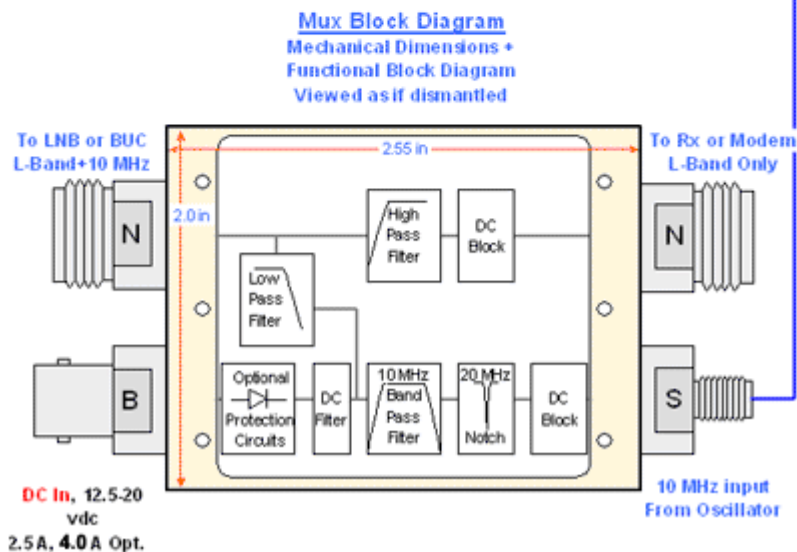

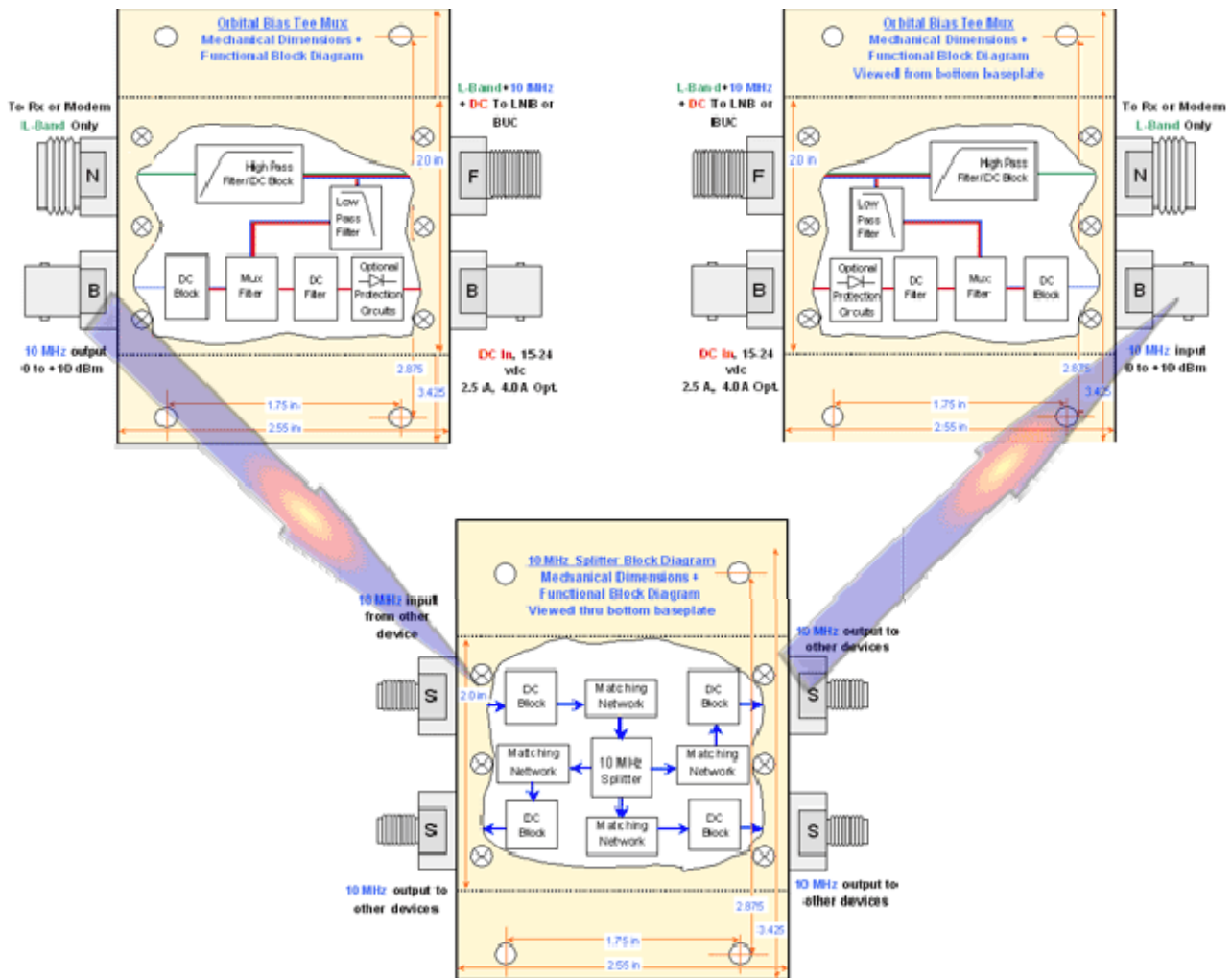

**10 MHz Pass Around**

Although you don't need a 10 MHz Splitter to simply extract and re-insert the 10 MHz signal, you may want to use a Splitter to feed another device and/or create a test point for the 10 MHz reference.

With today's high-power BUCs, the Modem often cannot supply sufficient power to the BUC, but if you simply insert DC power into the combined signal, you swamp the 10 MHz with DC power, thus losing your external reference. You can use a reversed Mux Tee to extract the 10 MHz reference from the Modem, and then re-insert it into a second MT25/40 to mux the 10 MHz reference back into the feed for the BUC. This allows you to insert power from an external source to the BUC through the second Mux Tee.

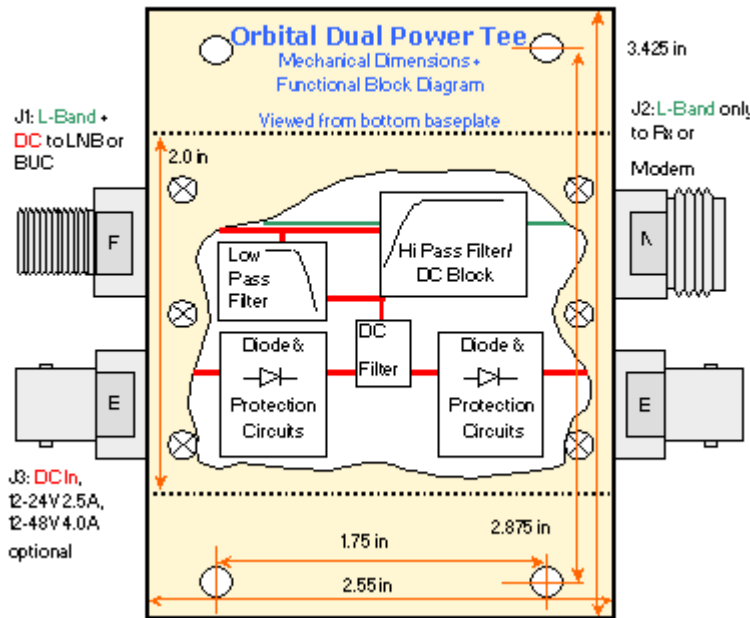

**We have a special version of MT25/40 to provide a basic level of redundancy - DPT - Dual Power Tee**, a System Interface Product (SIP), that is a Bias Tee with two DC inputs for redundant power supplies. As with the Bias Tee, the Dual Power Tee injects and filters external DC to the LNB/BUC, while providing exceptional through loss with highpass filtering of the L band signal. Additional features of the Dual Power Tee are Transorbs - to protect the LNB/BUC and other components from power spikes. The diodes are Schotkky - to yield high power, but with a low barrier voltage to minimize voltage drop. Inductors are placed in each DC line to provide AC isolation between each output, along with filters to provide proper bypass. A DC filter mitigates interaction between the power supplies.

**Contact Orbital Research at:**

**Tel: (604)419-8585**  
**Fax: (604)419-8561**  
**email: [sales@orbitalresearch.net](mailto:sales@orbitalresearch.net)**  
**website: [www.orbitalresearch.net](http://www.orbitalresearch.net)**